

ENHANCED PARKING STRUCTURES

IMPROVED DURABILITY AND RELIABILITY WITH LESS COST

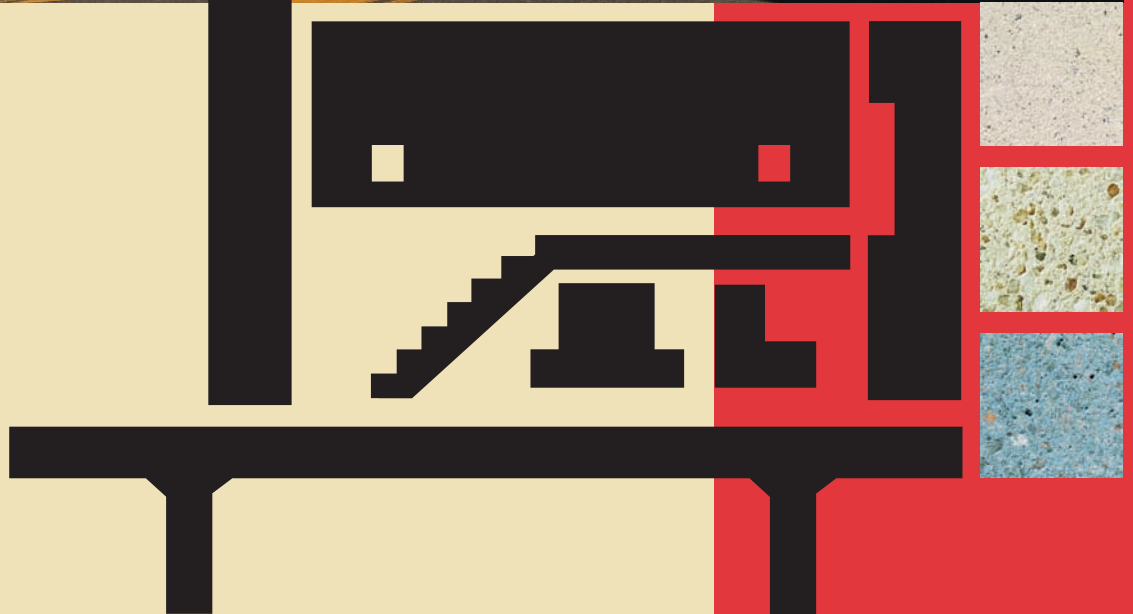

CONCRETE INNOVATIONS & ANSWERS®



iHIGH CONCRETE GROUP LLC
An Affiliate of High Industries Inc.

Lehigh University Alumni Parking Garage

Allentown, Pennsylvania
315 vehicles, 102,500 sq. ft., five levels.

A design-build project, this contemporary structure blends effortlessly with adjacent historic fieldstone buildings. The creative form work from this PCI Design Award winner was reused from a previous project.

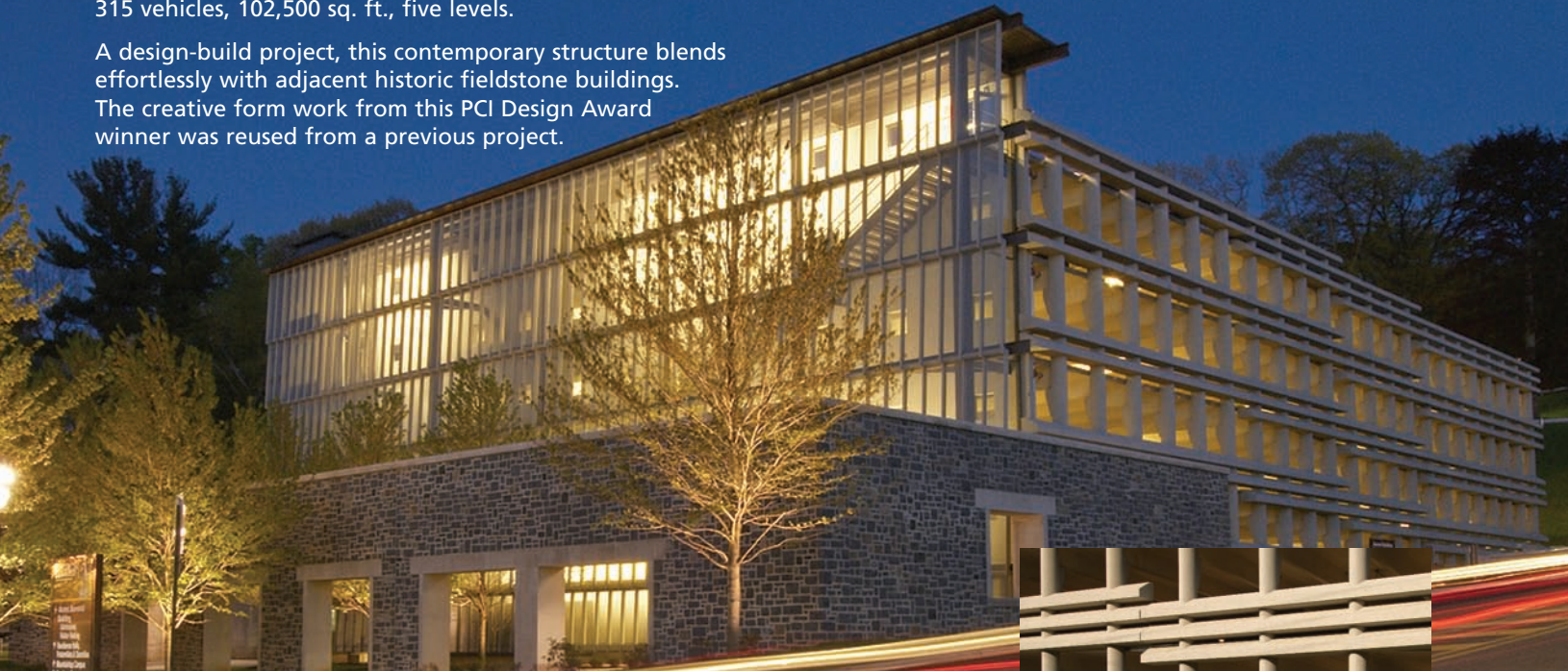

ENHANCED PARKING STRUCTURE: A NEW APPROACH.

Practical, beautiful, worry-free, and sustainable, precast concrete is the most-chosen parking garage type in the United States. As one of the largest and best-known producers of precast concrete parking garage systems, High Concrete Group listens when customers speak. In answer, we have enhanced our parking system offering with recent innovations that make precast garages more cost-effective, durable, and reliable than ever before. Together, they support a new design approach that anticipates your parking structure needs both now and into the future.

Practical

Designers choose precast concrete for more than half of above-ground parking structures because it is a durable, cost-effective solution that installs quickly.

Beautiful

Choose from an extensive palette of colors, textures, finishes, and veneers to create the best expression for your parking structure.

Worry-free

Expert design assistance and proven technology assure a high-performance system that brings peace of mind.

Sustainable

Today's precast concrete can be made lighter in weight, so it contains less embodied energy. Recycled content further reduces your project's carbon footprint.



New Brunswick Gateway Transit Village Garage

New Brunswick, New Jersey
697 vehicles, 278,000 square feet, 10 levels.

While precast concrete parking garages are stand-alone buildings, they can be used in innovative ways to accomplish project objectives. Here, a 14-story building was placed on top of a garage.



Lancaster Central West Garage

Lancaster, Pennsylvania
405 vehicles, 151,200 sq. ft., seven levels.

Built with CarbonCast® Double Tees to ensure durability and low maintenance, this thin brick-clad design plays well with its 19th-century row home neighbors.

“We’ve done a good deal of work with structural precast concrete. In our opinion, it’s less expensive than other parking garage systems in both initial and life-cycle costs. It made sense to go with the same system we’ve used before.”

Ross Ansel, Greenfield Architects



IMPROVING DURABILITY WHILE REDUCING COST.

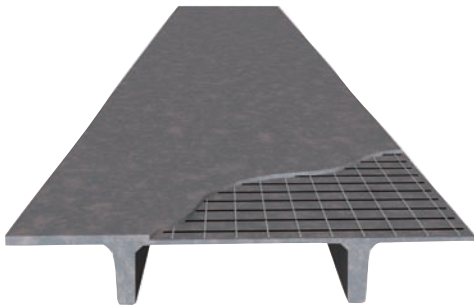

Today’s precast concrete can be designed to be lighter in weight and lower in embodied energy than ever. Using the latest technologies, High Concrete Group can help reduce your project’s carbon footprint and improve long-term performance.

CarbonCast® Double Tees for Long-term Durability

Precast concrete is a durable and versatile building material, but parking structures are one of the most demanding applications even for concrete. To extend service life and reduce maintenance costs, High Concrete Group offers CarbonCast Double Tees, with C-GRID® carbon fiber mesh replacing conventional steel mesh flange reinforcing.

CarbonCast is an excellent choice in the Mid-Atlantic and Midwest, where it withstands chloride exposure from winter deicing salts and coastal climates and can

be erected year-round. Because C-GRID is non-corrosive, it eliminates double tee flange cracking and spalling caused when steel mesh reinforcing corrodes.

CarbonCast Double Tees also require less concrete cover, and do not require sealer for protection from chloride-laden water. The weight of a CarbonCast Double Tee

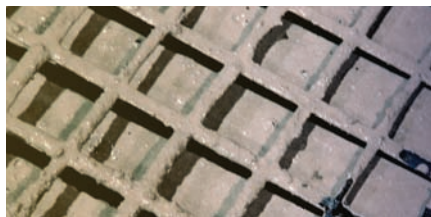

is about eight percent less than that of a conventional member, which represents a substantial savings in embodied energy and greenhouse gas emissions associated with Portland cement.

High Concrete Group produces 12'-wide double tees as well as 15'- and 16'-wide MEGA-Tees™. The larger member sizes help to reduce shipping costs during the project as well as the number of joints to be maintained in the long term.

Fire-rated Double Tees with Four-inch Flanges

For years, parking structures with a two-hour fire rating required 4-3/4" -thick

double tee flanges, or tees made with special aggregates, to resist heat transmission. However, the International Building Code (IBC) didn’t require shaft enclosures or fire-resistive joints, indicating there was no intent to create a fire barrier between floors and ramps. With the 2015 IBC, this inconsistency has been corrected:



722.2.2.1 Reinforced and prestressed floors and roofs. The minimum thicknesses of reinforced and prestressed concrete floor or roof slabs for fire-resistance ratings of 1 hour to 4 hours are shown in Table 722.2.2.1

Exception: Minimum thickness shall not be required for floors and ramps within open and enclosed parking garages constructed in accordance with Sections 406.5 and 406.6, respectively.

The concrete cover requirement to protect reinforcement is still in force.

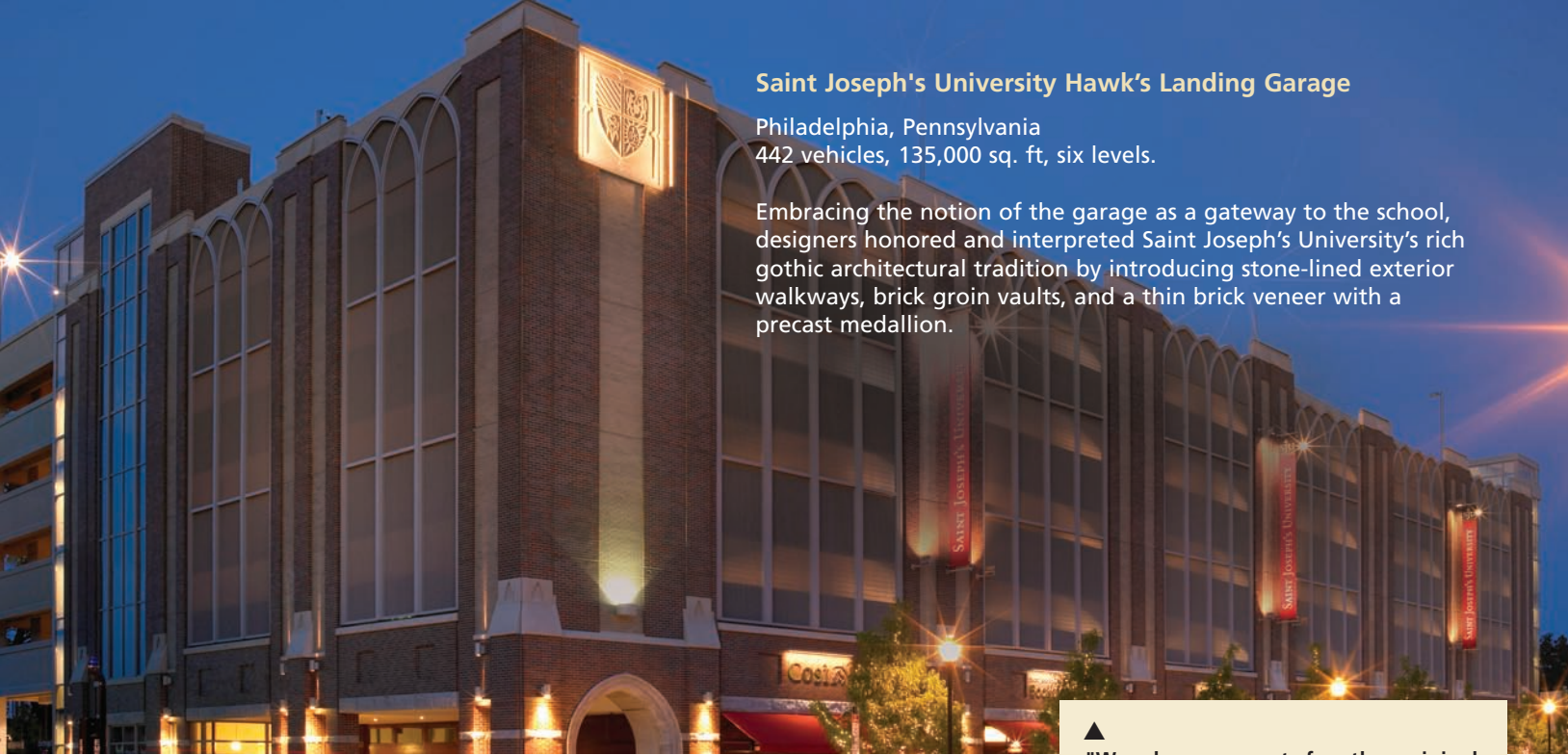

Saint Joseph's University Hawk's Landing Garage

Philadelphia, Pennsylvania
442 vehicles, 135,000 sq. ft, six levels.

Embracing the notion of the garage as a gateway to the school, designers honored and interpreted Saint Joseph's University's rich gothic architectural tradition by introducing stone-lined exterior walkways, brick groin vaults, and a thin brick veneer with a precast medallion.

IMPROVING SEISMIC PERFORMANCE AND CRACK CONTROL.

Post-Tensioned Lateral Reinforcement

Post-tensioning can be used to provide effective lateral load resistance. This is a desirable construction technique for designers who choose to do away with most field-applied pour strips that bring the potential for corrosion of diaphragm reinforcing steel.



Precast stressing bulkhead resists post-tensioning forces.



Post-tensioning standard conduit pass through double tee stem blockout.

Post-tensioned lateral reinforcement is useful in all double tee applications up to 15' and 16' widths. The flange portions of adjacent prestressed double tee beams are transversely post-tensioned together, replacing traditional methods used to resist lateral loads. Pour strips and cast-in reinforcing can be mostly eliminated, reducing costs, improving concrete quality, and shortening field erection schedules.

▲
"We chose precast for the original design of the garage because it gave us more flexibility than cast-in-place. We also thought it was the best, most economical system in terms of initial cost and long-term maintenance."

John Pringle, Burt Hill (Stantec)

▼
In their choice of the River Street Garage in Harrisburg, Pennsylvania, for Best Parking Structure, PCI Design Award judges said, "This project was a unanimous choice of the jury due to its innovative use of big, horizontal precast pieces. It creates a nice balance between heavy elements and light elements while providing an open design. The architects devised a unique design that worked very well for this situation."

River Street Garage

Harrisburg, Pennsylvania
850 vehicles, 285,000 sq. ft., eight levels.

The innovative spandrel design provides a striking visual and safe vehicle barriers while bringing daylight deep into the structure.

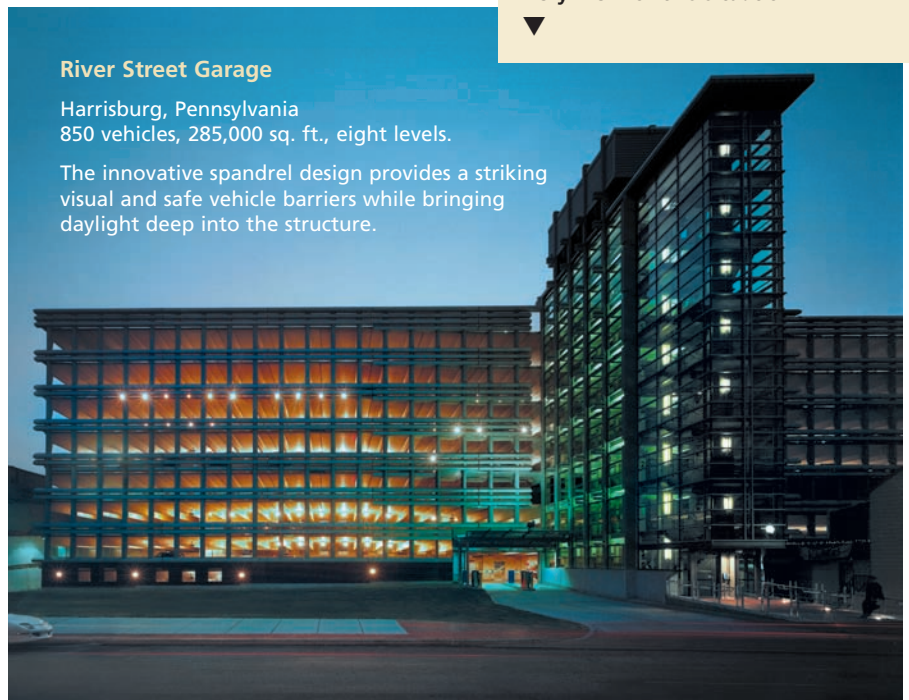

Amtrak 30th Street Station Garage

Philadelphia, Pennsylvania.
1,525 vehicles, 495,000 sq. ft., nine levels.

After evaluating both prestressed precast, and post-tensioned cast-in-place systems, the design team chose precast for its economy, aesthetics, and speed of construction. 15'-wide MEGA-Tees™ reduced the number of pieces that needed to be transported and erected, and the number of joints to be maintained.



DESIGNING GOOD DRAINAGE TO ENSURE NO STANDING WATER.

Getting stormwater and snow melt out of a parking garage is a priority for owners and their customers. A nuisance and a potential safety hazard, standing water can seep into concrete and attack the steel reinforcement. Chloride-laden water can accelerate the rusting process, shortening the life of the parking structure.

To ensure longevity of the structure, water should drain from concrete surfaces completely and be directed to in-floor drains. Integral washes, as opposed to field-applied washes, improve deck integrity and performance because the higher strength precast concrete is more impermeable to water than cast-in-place concrete, and assures positive drainage. And, there is no joint between the pre-topped precast tee and a field-poured wash where water can penetrate to cause joint failure and spalling as in a cast-in-place wash.

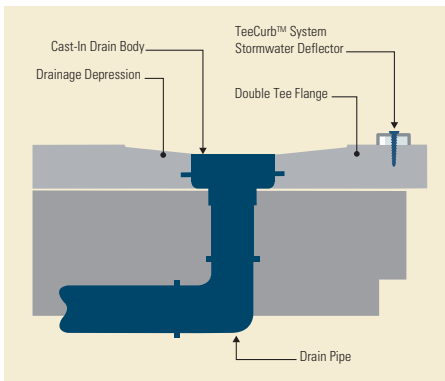

Cast-in Drains

High Concrete Group's design strategy leverages the high degree of control possible in a factory environment. We cast industry-standard, heavy-duty cast iron drain bodies into double tee corners based on the parking garage area each must serve. Placed in

collectors at the proper elevation for positive drainage, these drains do not rely on hand-finished drainage channels or washes. Cast-in drains also eliminate lower-strength, field-applied concrete that is less durable than precast concrete.

To help move water to the drains, High Concrete Group introduces warping to the double tee ends to provide as much as 3/16" slope per foot of width. If more slope is required, the double tees may be post-tensioned transversely to resist cracking.

TeeCurb™ System Stormwater Deflector

At the ends of the double tees, High Concrete Group's aesthetically-pleasing TeeCurb System provides an economical and effective water barrier. Developed in conjunction with an ornamental metal expert, the proprietary system prevents leaking, shadowing, and staining without expensive concrete curbs, ski slopes, or pour strips.

TeeCurb seals out flowing water with compressible silicone foam, preventing it from passing over the edge of the double tee to lower levels and directing it toward drains. Extruded aluminum channels securely fastened to the concrete surface span the width of each double tee; a matching slip-jointed sleeve connects the ends where they meet. TeeCurb is easily installed by on-site labor with standard tools. Located next to walls and spandrels, the system is out of the way of foot traffic and provides a neat, finished appearance.

▲
"The fact that an exit walkway was required from the stair tower to the street gave us an opportunity to create large-scale, monumental gridwork on the eastern face of the garage."

Michael Ytterberg, BLT Architects



Cast-in drains are positioned at the corners of double tees.



The TeeCurb System directs stormwater to drain without expensive concrete curbs, ski slopes, or pour strips.

Pennsylvania Judicial Center Complex Garage

Harrisburg, Pennsylvania
805 vehicles, 247,000 sq. ft., five levels.

The precast concrete components have a light and medium sandblast buff finish, which matches the Indiana limestone used on the Harrisburg Judicial Center and the other buildings of the complex. At a distance the precast looks like limestone, but at a significant cost savings compared to using real limestone for the facade.

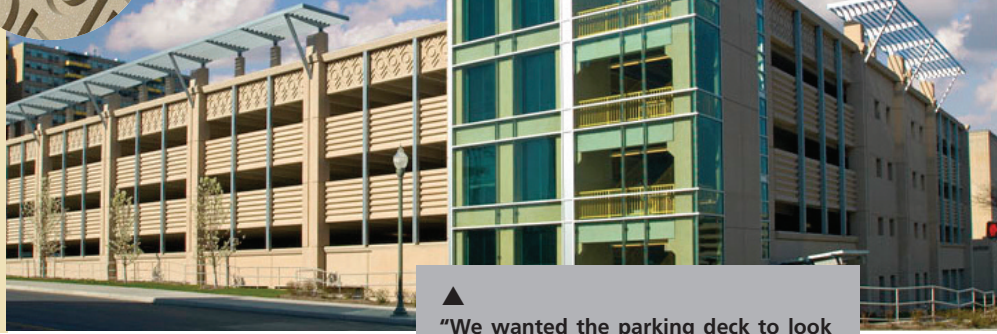

▲ "We wanted the parking deck to look as much like [the other buildings of the complex] as possible. We hid the ramp inside the structure and utilized square openings on the exterior to mimic windows."

JoAnn Jolin, Vitetta Group

MAKING PRECAST CONCRETE MORE SUSTAINABLE.

High Concrete Group is dedicated to sustainable building. In addition to light-weight precast concrete components, we offer admixtures and finishes to help you achieve your sustainability goals.

High Solar Reflectance Concrete

High Concrete Group offers a new high solar reflectance index (SRI) concrete mix design of up to 82, that nearly doubles the SRI of conventional precast concrete surfaces. The mix uses 75 percent white cement and 25 percent ground granulated blast furnace slag, a recycled material, for the cementitious content. Local limestone aggregates provided a neutral-colored base. High solar reflectance concrete can contribute directly to Sustainable Sites Credit 7.1: Heat Island Effect: Non-Roof in the USGBC's LEED® Rating System.

ECast

ECast™ is a weight-saving precast concrete that allows us to strategically tailor the weight of precast members to your specific project requirements. Formulated from lightweight sands and aggregates, ECast helps to directly reduce transportation costs and fuel use. High Concrete Group uses ECast to optimize truckloads, as when weight adjustments will allow two pieces to ship versus only one. Weighing from 110 to 149 pounds per cubic foot, ECast can also reduce the size of the crane needed to erect a building. Designing with lightweight ECast in mind can allow architects to safely reduce a building's foundation and superstructure requirements.



EcoMix®

EcoMix allows architects and designers to reduce cement-related carbon dioxide by up to 50 percent by displacing Portland with supplementary cementitious materials. These include ground granulated blast furnace slag and silica fume that are derived from industrial waste stream products. The materials may be used individually or as a blend, and can improve the light reflectance, workability and other characteristics of precast concrete. EcoMix can contribute directly to credits in the USGBC's LEED® Rating System.

Recycled Aggregates from Wash Out

High Concrete Group reclaims aggregates and water for reuse in the production of precast concrete. One of the few of its kind in the industry, the system employs vacuum filtration, a significant advance over standard settling basin technology, that conserves approximately 10,000 gallons of water per day that otherwise would be lost to evaporation. All wash water from transport mechanisms, batching process mixers, trucks, and buckets is captured. Coarse and fine aggregates are settled out, and cement and other particles are trapped for disposal. A system of tanks and weirs (spillover devices) controls the water through various stages of treatment and minimizes the risk of contaminants escaping into the environment.



Applied Veneers

Thin brick veneer is an extremely popular design option and an excellent sustainable alternative to traditional hand-laid installations. Engineered for embedment in precast

concrete surfaces, the materials take as little as one-fifth the energy to produce as their full-depth counterparts. Recent advances capture convincing visuals that can be blended with hand-laid materials. With a three to six percent moisture absorption rate, and with 5,000-plus psi precast concrete forming the joints, thin brick forms a very durable finish that requires no tuck pointing or sealing, and won't crack, spall, split, or pop out over time. Veneers of stone, tile, and other materials are also available.



Berwyn Municipal Parking Garage, Berwyn, Illinois.

ENHANCED PARKING STRUCTURES DETAILS

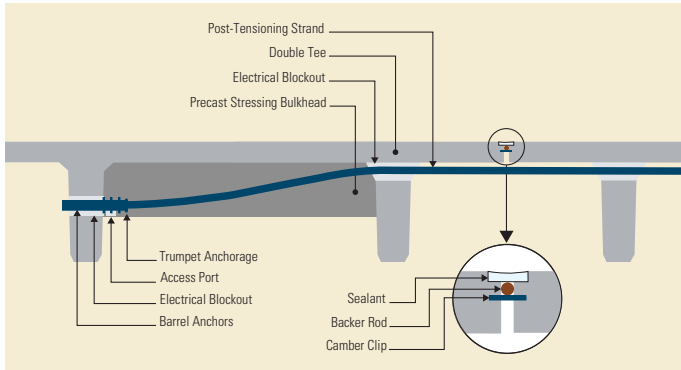

Post-Tensioned Tees—Precast Stressing Bulkhead
Horizontal Section

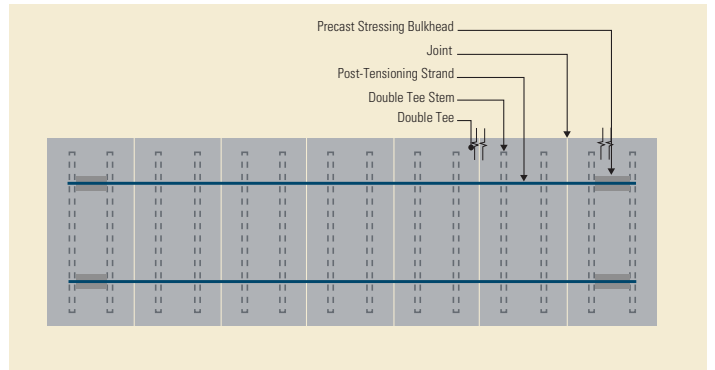

Post-Tensioned Tees
Plan

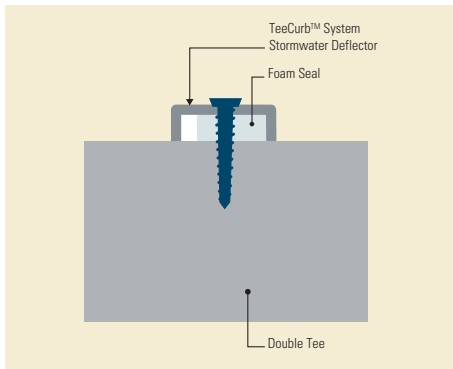

TeeCurb™ Stormwater Deflector Detail
Horizontal Section

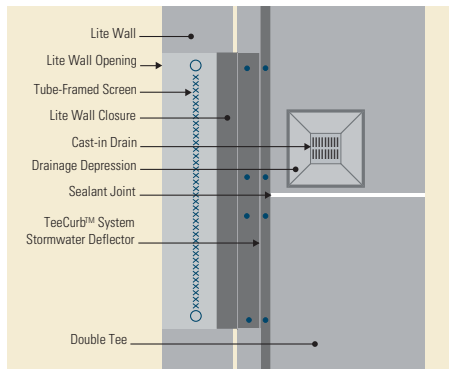

TeeCurb™ System with Drain
Plan

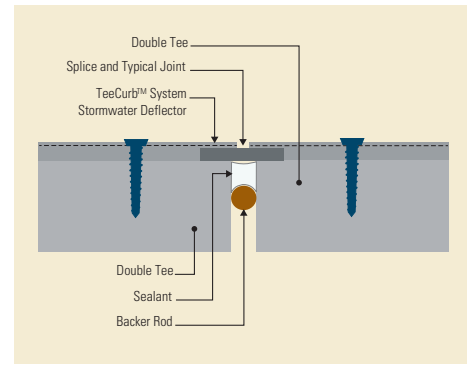

TeeCurb™ System—Splice and Typical Joint
Elevation

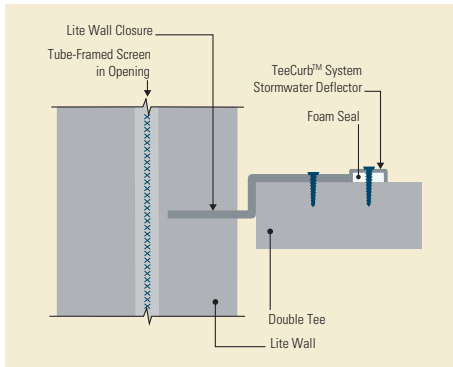

TeeCurb™ System at Lite Wall
Horizontal Section

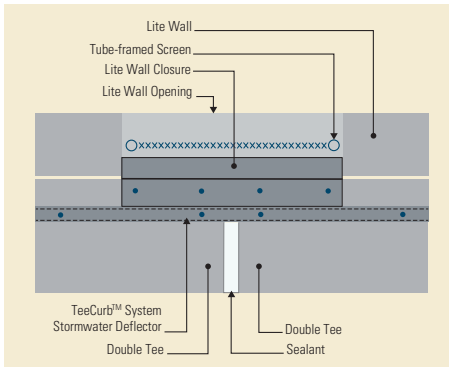

TeeCurb™ System at Lite Wall
Plan

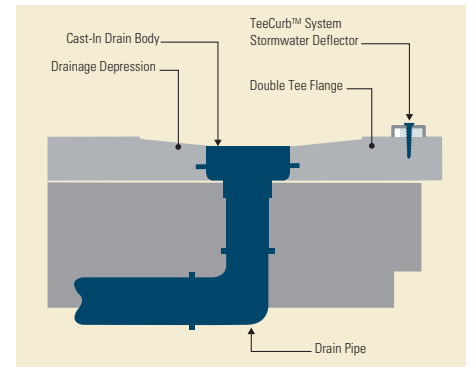

TeeCurb™ Drainage System
Horizontal Section

ENHANCED PARKING STRUCTURES DETAILS

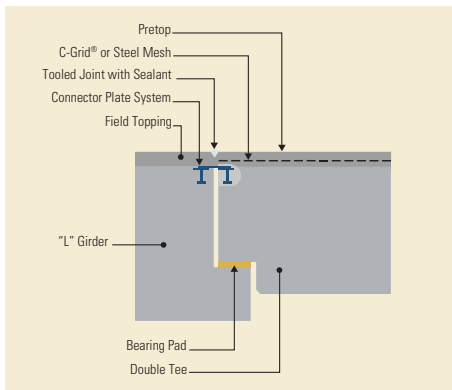

Pretopped Tee-'L' Girder wash
Horizontal Section

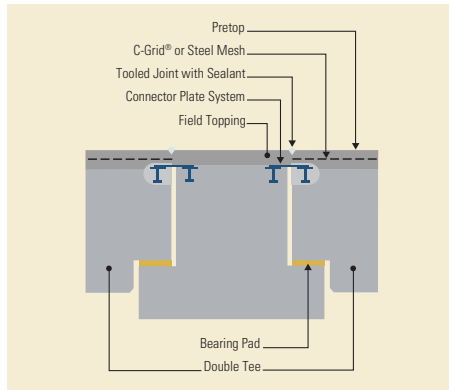

Pretopped Tee—Inverted 'T' Girder Wash
Horizontal Section

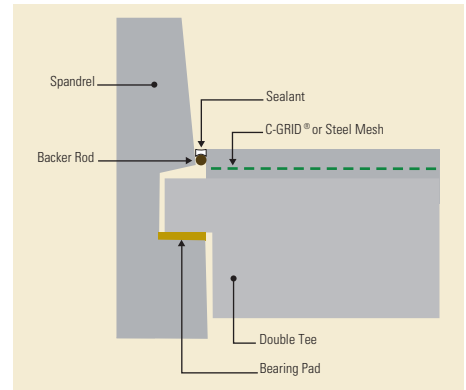

Optimized Spandrel Pocket Bearing
Horizontal Section

High Concrete Group offers product innovation, proven technology, and more than 50 years of architectural and structural precast concrete experience. We provide technical support for each stage of your project to help you achieve your design, cost, schedule, and lifecycle performance requirements. Serving Southern New England, the Mid-Atlantic, the Ohio Valley, and the Midwest, High Concrete Group is dedicated to bringing your designs to life.



An Affiliate of High Industries Inc.

High Concrete Group LLC
www.highconcrete.com
1.800.PRECAST (800.773.2278)
concrete.answers@high.net

125 Denver Road
Denver, PA 17517
717.336.9300
717.336.9301 (fax)

95 Mound Park Drive
Springboro, OH 45066



Meet High—We provide
Concrete Innovations & Answers®

CarbonCast is a registered trademark of AltusGroup, Inc. C-GRID is a registered trademark of Chomarat NA. LEED® is a registered trademark of the US Green Building Council. All other trademarks are the property of High Concrete Group LLC.

© High Concrete Group LLC